

WIFI Module

USER'S MANUAL



Please read this user's manual carefully before use
Please keep this user's manual properly

User Privacy Instructions

We take your privacy very seriously and we promise to inform you how we use the data. Users' private data, such as mailboxes, address, before uploading to the cloud, we will get your permission, and we will work hard to protect your data security.

Description

- Receive data signal from cloud server and transmit to the main device;
- Receive data signal from main device and transmit to cloud server;
- To achieve remote upgrade the WIFI module baseplate MCU by cloud server;
- To achieve the remote upgrade of the main device by WIFI module baseplate MCU.

Technical Parameters

OPERATING VOLTAGE: DC8V~12V (Recommended value 12V)

OPERATING CURRENT: Max. recurrent peak 1A, average standby current 50mA

TEMP. RANGE: Operating Temp.: -30℃~+70℃; Storage Temp.: -40℃~+85℃

LED INDICATOR LIGHT:

4 lights, Network configuration indicator,router connection indicator, cloud server connection indicator, 485 communication indicator;

DIMENSION(L×W×H): 78mm×63mm×24mm

Installation

- There is a magnet on the back of the WIFI module, it can be installed indoors or outdoors, and avoid direct sunlight;
- Please scan the following QR code to download APP;



Functional Description

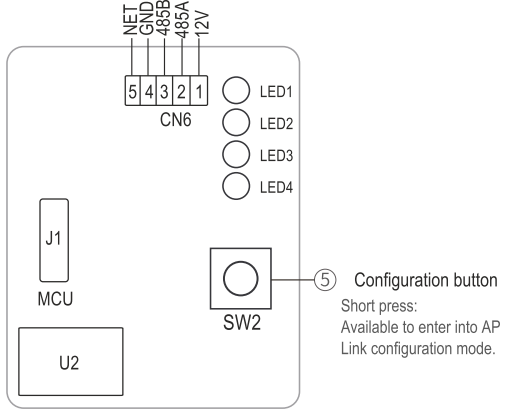
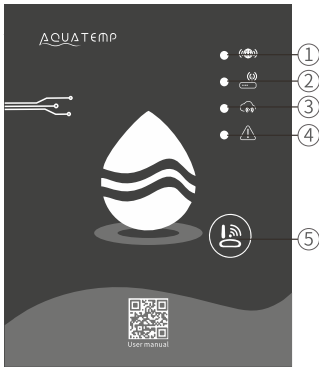

MXL-WX17

ITEM	NAME	LONG LIGHT	SLOW FLASH	EXTINGUISH
①	Network configuration indicator	Configuring Network	SmartLink configuring	Done
②	Router connection indicator	Normal	Abnormal	----
③	Cloud server connection indicator	Normal	Abnormal	----
④	485 communication indicator	Normal	Abnormal	----

Account Login

Use email address and password to register, login or reset the password.

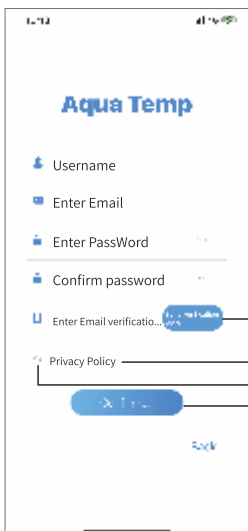

Fig.2 Account Registration interface

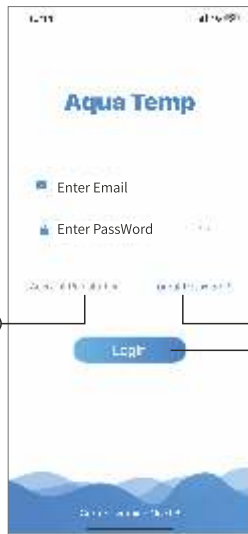

Fig.1 Login interface

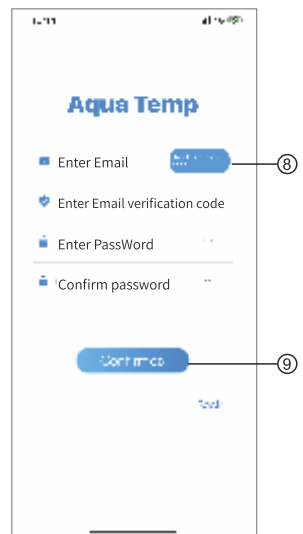

Fig.3 Forgot Password interface

1. Account Registration: To register an account, click ① (Fig.1) to jump to the Account Registration interface, fill in the relevant information and click ② to receive verification code, while completed the application information, click ③ to read the details of the Privacy Policy, then click ④ to agree, and click ⑤, registration is done.

Please note, the valid time of one verification code is 15min, please fill in the verification code within 15min, otherwise you need to ask for a new one.

2. Log in: Follow the instructions on the page(Fig.1), enter your registered email address and password, click ⑥ and jump to device list;

3. Forgot Password: While forget your password, click ⑦ (Fig.1), jump to the Forgot Password interface (Fig.3). Follow the instructions on the page, fill in the relevant informations, click ⑧ to receive verification code from your mailbox, click ⑨ to confirm and password reset is done.

Add Device

After log in, displays My Device interface (Fig. 4) , follow the instruction to add WIFI or DTU.

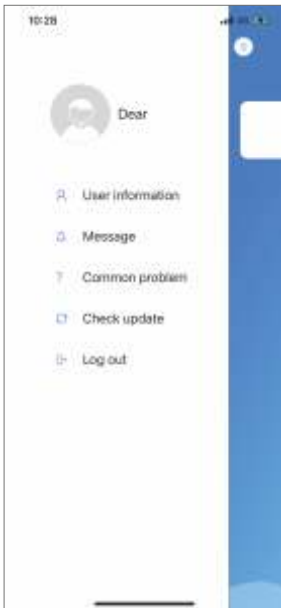

Fig.5 The left-hand menu



Fig.4 My Device interface

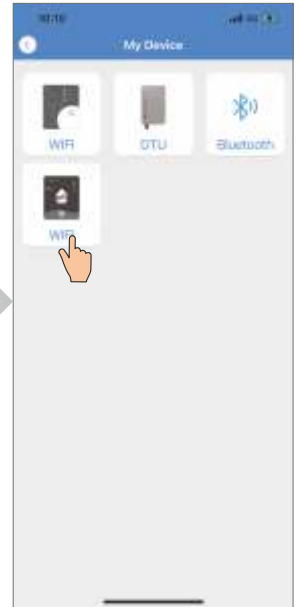

Fig.6 Add Device interface

IOS WIFI Configure Network



Fig.7 Permission confirmed interface



Fig.8 WIFI Module On interface

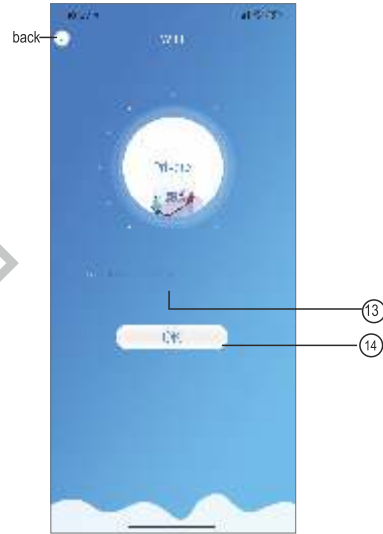

Fig.9 Enter password interface

1. Click ⑩ to confirm the permission of bluetooth,location and camera(Fig.7);
2. Follow the instructions on the page (Fig.8), press button on module and hold for 1s till two lights on, then AP connection is activated, click ⑫ to next;
3. Click ⑬ to enter the WIFI password for the current connection, click ⑭ to confirm.



Fig.10 Allow bluetooth permission



Fig.11 Enable bluetooth permission



Fig.12 Bluetooth setting interface

4. Click "OK" to allow bluetooth permission (Fig.10);
5. Click "Settings" (Fig.11) to enter bluetooth setting interface(Fig.12);
6. Turn on bluetooth and back to the APP, directly enter the searching device interface(Fig. 13), If the connection fails or succeeds, a pop-up window will appear. If the connection fails(Fig.14-1/Fig.14-2), try again as prompted. If successful(Fig.15), check the light 1 of the wifi module indicator, and then select the operation according to the prompts.
7. Click ⑮ to bond device (Fig.16);
8. Click "OK" (Fig.17) to allow the App to use the camera for scanning the WF code on the WIFI module (Fig.19.1), or click "manual input" to enter the WF code(Fig.19.2).

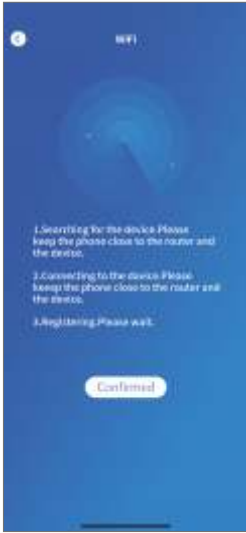

Fig.13 Searching device interface



Fig.14-1 No network interface



Fig.14-2 Can't connect to the wifi interface



Fig.15 Device search succeeded interface



Fig.16 Bond device interface



Fig.17 Enable camera permission



Fig.19.2 Manual input interface

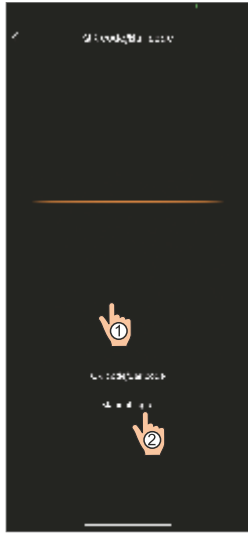

Fig.18 Scanning interface



Fig.19.1 WF barcode

9. Click "Confirmed", device bond is done (Fig.20).
10. After WIFI bonding is done, and jump back to My Device(Fig.21);
11. Click the device directly jump to device main interface(Fig.22).



Fig.20 Bond device done interface

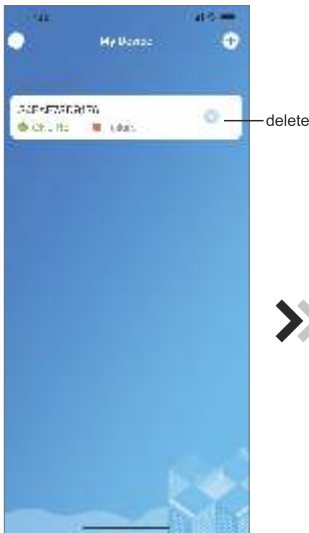

Fig.21 Device management interface



Fig.22 Device Main interface

Android WIFI Configure Network



Fig.23 Permission confirmed interface

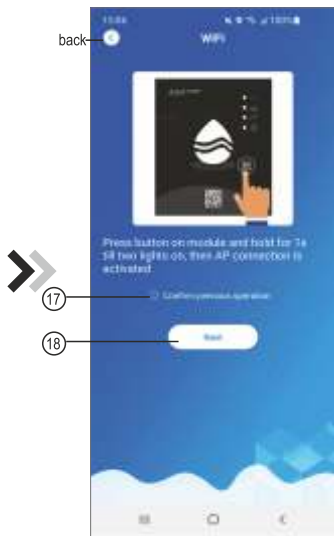

Fig.24 WIFI Module On interface

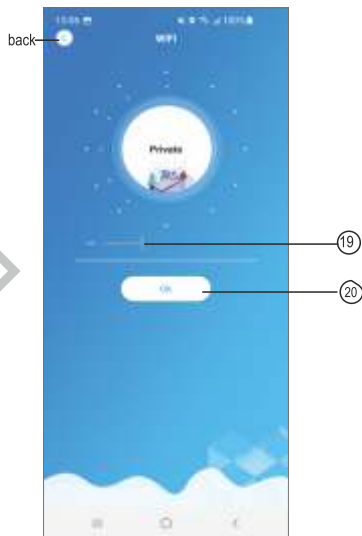

Fig.25 Enter password interface

1. Click 16 to confirm the permission of bluetooth,location and camera(Fig.23);
2. Follow the instructions on the page (Fig.24), press button on module and hold for 1s till two lights on, then AP connection is activated, click 18 to next;
3. Click 19 to enter the WIFI password for the current connection, click 20 to confirm.

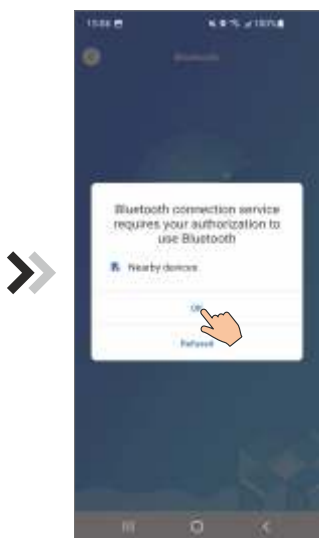

Fig.26 Enable bluetooth permission

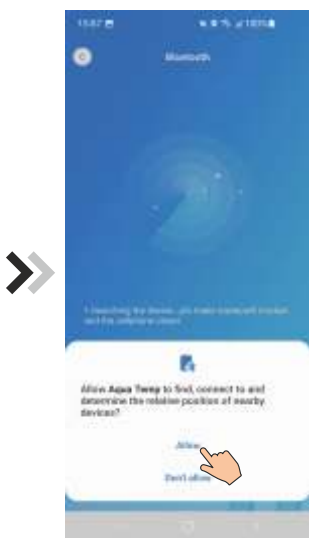

Fig.27 Enable location permission



Fig.28 Reconnect interface

4. Click "OK" to enable bluetooth permission (Fig.26);
5. Click "Allow" to enable bluetooth permission (Fig.27);
6. Click "Reconnect" (Fig.28) directly jump to searching device interface(Fig.29), If the connection fails or succeeds, a pop-up window will appear. If the connection fails(Fig.30-1/Fig.30-2), try again as prompted.
- If successful(Fig.31), check the light 1 of the wifi module indicator, and then select the operation according to the prompts.
7. Click ②1 to bond device (Fig.32);
8. Click "While using the app" allow the App to use the camera for scanning the WF code on the WIFI module (Fig.35.1), or click "manual input" to enter the WF code(Fig.35.2).



Fig.29 Searching device interface



Fig.30-1 No network interface



Fig.30-2 Can't connect to the wifi interface



Fig.31 Device search succeeded interface

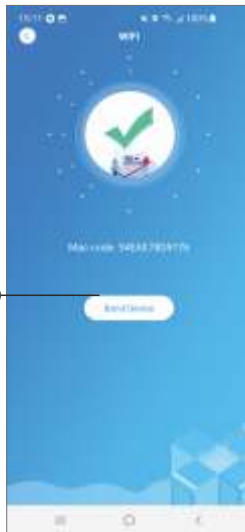

Fig.32 Bond device interface

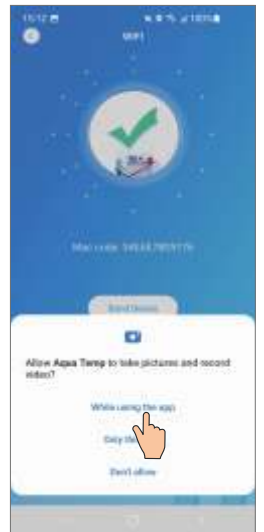

Fig.33 Enable camera permission

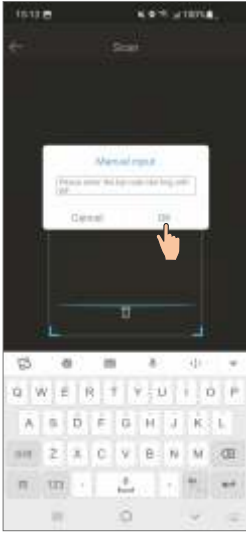

Fig.35.2 Manual input interface



Fig.34 Scanning interface



Fig.35.1 WF barcode

9. Click "OK", device bond is done (Fig.36).
10. After WIFI bonding is done, and jump back to My Device(Fig.37);
11. Click the device directly jump to device main interface(Fig.38).



Fig.36 Bond device done interface

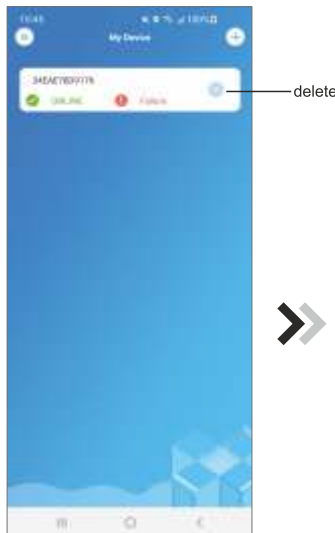

Fig.37 Device management interface



Fig.38 Device Main interface

Device Management

Device management operations are as below :



Fig.39 Device Main interface

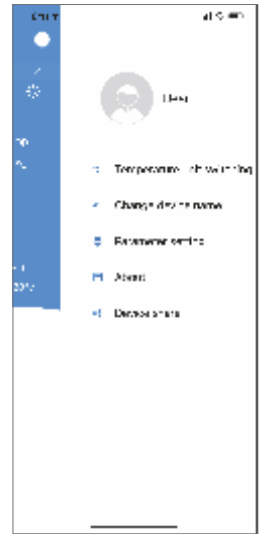

Fig.40 The right-hand menu interface











Fig.42 Timing Settings interface



Fig.41 Device Main interface



Fig.43 Troubleshooting interface

ICON	NAME	FUNCTIONS
	ON/ OFF	Click it to turn on/ off the unit
	Silent Mode Off	Display silent mode off, click it to activate the silent mode
	Silent Mode On	Display silent mode on, click it to turn off the silent mode
	Mode shift	Mode changing: Cooling--Heating--Auto
	Cooling	Display Cooling mode, click it to change operating mode
	Heating	Display Heating mode, click it to change operating mode
	Auto	Display Auto mode, click it to change operating mode
	Timing settings	Click it to jump to the timer on/ off and mute timer setting interface
	Troubleshooting	Click it to jump to the troubleshooting interface
	Menu	Click to unfold or collapse the menu